

This manual covers installation and operating instructions for the following 3Com modem:

U.S. Robotics 56 kbps* Winmodem™

U.S. Robotics is a registered trademark and *Connections*, RapidComm, and x2 are trademarks of 3Com Corporation and its subsidiaries. Windows is a registered trademark of Microsoft Corp. CompuServe is a registered trademark of CompuServe Inc. America Online is a registered trademark of America Online Inc. Any other trademarks, trade names, or service marks used in this manual are the property of their respective owners.

© 1998 3Com Corporation
7770 North Frontage Road
Skokie, IL 60077-2690
All Rights Reserved

* **IMPORTANT!** In accordance with the ITU-T standard for 56K transmissions, this modem is capable of 56 Kbps downloads. However, due to FCC rules which restrict power output of the service providers' modems, current download speeds are limited to 53 Kbps. Actual speeds may vary depending on line conditions and other factors. Uploads from users to server equipment travel at speeds up to 31.2 Kbps. An analog phone line compatible with the ITU-T 56K standard or x2 technology, and an Internet provider or corporate host site compatible with the ITU-T 56K standard or x2 technology are necessary for these high-speed downloads.

TABLE OF CONTENTS

Welcome to 56k Information Access	1
Product Features	2
Windows 3.x Installation	3
How to Insert the Modem	4
Running the Installation on a Windows 3.1 or 3.11 System	8
Before You Begin (Windows 95 Users)	13
Windows 95 Installation	14
How to Prepare For Plug and Play	14
Checking Your Version of Windows 95	14
Checking Your System's Resources	16
How to Insert the Modem	17
Installing the Winmodem Software in Windows 950a	21
Installing the Winmodem Software in Windows 950b	22
Un-Installing the Winmodem Software in Windows	26
Software Installation and Testing	29
Software Installation and Registration Using the Update Wizard	29
Starting the Wizard	30
Installing the RapidComm Fax/Data Software	31

TABLE OF CONTENTS

Installing Other Fax/Data Software	32
Type of Modem	32
Initialization String	32
Flow Control	33
Using Modem Station	34
Why Modem Station?	34
What Does Modem Station Do?	34
Installing Modem Station	34
Starting Modem Station	37
Using Detect New Modems	39
Using Terminal	40
Using Modem Configurator	43
Using Modem to Computer	46
Using the Extended Information Screens	50
U.S. Robotics Update Wizard	56
Installing the Wizard	57
Updating Your Modem	57
Troubleshooting and Online Help Resources	58
Problems and Solutions	58
Online Help Resources	69
Are You Still Having Problems?	72
If You Need to Return the Modem to 3Com	73

TABLE OF CONTENTS

Glossary	74
Regulatory Information	88
Manufacturer's Declaration of Conformity	88
Caution to the User	89
(Canada) IC	89
UL Listing/CUL Listing	89
Connecting to the Telephone Company	90
Fax Branding	90
Radio and Television Interference	91
For Canadian Modem Users	92
Limited Warranty	95

WELCOME TO 56K INFORMATION ACCESS

The International Telecommunications Union (ITU) decides the technical protocols communications devices must use to interoperate with each other. Modems that comply with ITU standards can “talk to” other standards-compliant modems and fax machines worldwide.

The ITU has decided on a worldwide 56K standard technology. So, now with a U.S. Robotics modem you can get all the Internet you want from any service provider who offers the ITU standard 56K technology or x2™ technology.

This modem will give you the most compatibility with high speed downloads from service providers that offer the ITU 56K standard technology or x2 technology to their customers. 3Com is working with providers everywhere to quickly upgrade their service to the ITU 56K standard.

* Capable of receiving up to 56 Kbps and sending up to 31.2 Kbps. Due to FCC regulations, receiving speeds are limited to 53 Kbps. Actual speeds may vary. Requires compatible phone line and server equipment. Complies with both the proposed ITU 56K standard and x2 protocols. ITU 56K standard officially determined in February, 1998; expected to be ratified in September, 1998. See www.3com.com/56k

PRODUCT FEATURES

Modulation Schemes

56K ITU-T standard
x2™ technology
ITU-T V.34+
ITU-T V.34
ITU-T V.32bis
ITU-T V.32
ITU-T V.22bis
ITU-T V.22
ITU-T V.23
Bell 212A
ITU-T V.21
Bell 103

Error Control and Data Compression Schemes

ITU-T V.42
ITU-T V.42bis
MNP 2-5

Fax Modulation Schemes

ITU-T V.17
ITU-T V.29
ITU-T V.27ter
ITU-T V.21

Fax Standards

EIA 578 Class 1 FAX
EIA 592 Class 2.0 FAX

Front Channel Link Rates

28000, 29333, 30666, 32000,
33333, 34666, 36000, 37333,
38666, 40000, 41333, 42666,
44000, 45333, 46666, 48000,
49333, 50666, 52000, 53333,
54666, 56000, 57333

Back Channel Link Rates

4800, 7200, 9600, 12000, 14400,
16800, 19200, 21600, 24000,
26400, 28800, 31200
33600

V.34+ Link Rates

4800, 7200, 9600, 12000, 14400,
16800, 19200, 21600, 24000,
26400, 28800, 31200, 33600

V.32bis Link Rates

4800, 7200, 9600, 12000, 14400

Additional Link Rates

300, 1200/75 (V.23), 1200, 2400

Fax Link Rates 2400, 4800, 7200,
9600,
12000, 14400

WINDOWS 3.x INSTALLATION

These instructions cover the installation of the Winmodem hardware and the accompanying software under Windows 3.x. These instructions are for users of either Windows® 3.1, Windows 3.11, or Windows for Workgroups.

You'll need these items from your U.S. Robotics modem box:

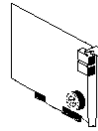

the modem



a phone cord



Connections CD



Guide

Winmodem disk



Installation

Plus:  **a screwdriver** *(not included)*

This chapter will walk you through the installation of your Winmodem. There are two parts to the installation: hardware (the modem) and software. The modem must be installed before the software.



NOTE: Your Winmodem supports Plug and Play installation, the fastest, easiest way to add new features (a modem, a sound card, etc.) to your PC.

How to Insert the Modem



NOTE: Before installing your modem, write down its serial number. (You'll find the serial number underneath the bar code on the white sticker on the modem and on the outside of the box the modem came in.) If you ever need to call our customer support department, a customer support representative will ask you for the serial number. This will help him or her identify your modem.

1. Shut down Windows, turn off your computer and unplug it from the electrical outlet.
2. Unplug any peripheral devices (printer, monitor, keyboard) from the computer.

WINMODEM INSTALLATION UNDER WINDOWS 3.X

TIP: Before you unplug anything, label the cords or make a sketch of how things are connected. This can be helpful when you plug things back in later.

CAUTION: To avoid the risk of electric shock, make sure your computer and all peripheral devices are turned off and unplugged.

3. Remove the screws from your computer's cover and then remove the cover. Your computer may look different from the drawing on the right, but the basic principle for removing the cover should be the same. Refer to your computer manufacturer's manual if you need further instructions.

4. Find an empty ISA expansion slot at least as long as the gold edge of your modem. (ISA slots have black plastic grooves lined with silver metal.) Unscrew and remove the expansion slot cover (the long narrow piece of metal that keeps dust from entering through the opening perpendicular to the slot.) Be careful not to drop the screw into the computer. You will need it later to screw the modem into place.

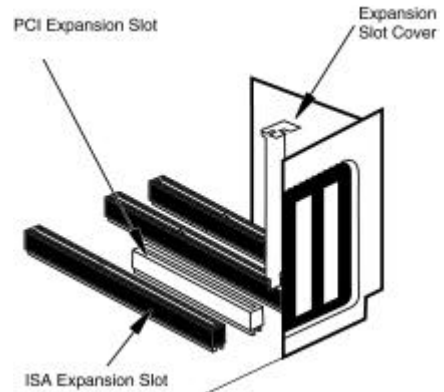

WINMODEM INSTALLATION UNDER WINDOWS 3.X

5. Holding the modem by each corner, align the gold edge with an empty expansion slot. Push down gently until the modem snaps into the slot. (Note: The drawing shows horizontally aligned expansion slots. Some computers have vertically aligned slots. The instructions apply to both styles.)

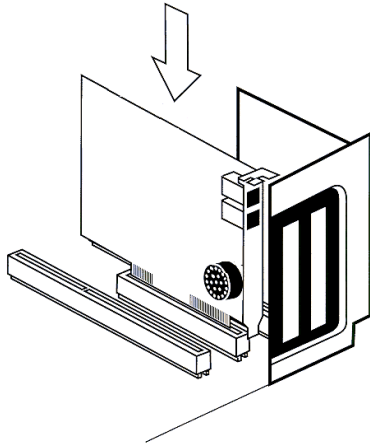

You'll have to apply a little pressure to seat the modem properly. Sometimes a gentle back-and-forth motion helps get the modem all the way into the slot. If you feel resistance, the modem may not be properly lined up with the slot. **Do not force it.** Take the modem all the way out and try again.

6. Once the modem is seated, secure it using the screw you removed in step 3.
7. Put the computer's cover back on and replace the screws.
8. If you currently have a phone plugged into the wall jack you're going to use for the modem, disconnect the phone's cable from the jack. (See *Warning statement on next page.*)

WINMODEM INSTALLATION UNDER WINDOWS 3.X

9. Plug one end of the phone cable that came with the modem into the TELCO jack at the rear of the modem.



WARNING : The phone jack you use must be an **ANALOG** phone line (the type found in most homes). Many office buildings have digital phone lines. Be sure you know which type of line you have. The modem will be damaged if you use a digital phone line.

10. Plug the other end of the cable into the wall jack.
11. If you want to use a telephone on the same line as the modem, plug the telephone's cable into the modem's PHONE jack.

12. Plug the power cords, cables, and peripherals back into the computer and turn the computer on.

13. If Windows does not start automatically, please start it now.

Modem Initialization

Your Winmodem came with a diskette that contains an installation program that will help your computer finish installing the modem. The installation program will also copy modem programs from the disk onto your computer's hard drive.

Running the Installation Program on a Windows 3.1 or 3.11 For Workgroups System

After inserting the Winmodem follow these steps:

1. Insert the installation diskette.
2. Click on **Program Manager**. Now click **File** and select **Run**. In the Command Line text box, type **a:\install.exe**. Click **OK**.

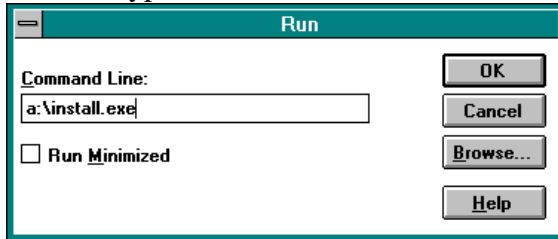

3. The next screen will tell you where the Winmodem installation files will be located. Click **Continue** to copy the Winmodem files to this directory. If you wish to copy the Winmodem files to a different directory, type the path to that directory in the **Install to** text box.

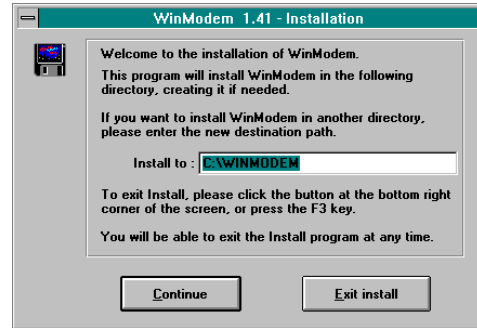

WINMODEM INSTALLATION UNDER WINDOWS 3.X

4. This screen tells you that the software will create the new Winmodem directory. Click **Yes**.



5. This screen lets you know the installation software is being loaded to your hard drive. Let it finish.

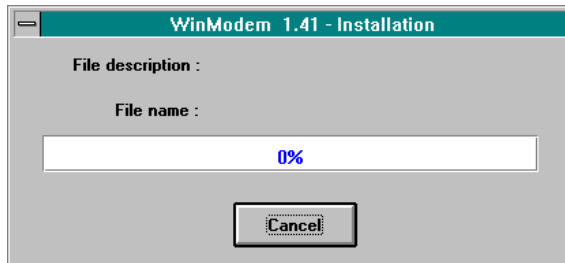

6. This screen tells you that modifications have been made to your Windows system files. Click **OK**.



7. This screen tells you that the software will automatically detect available communications ports for the Winmodem. Click **OK**.



WINMODEM INSTALLATION UNDER WINDOWS 3.X

8. After the software detects the available COM ports, it will ask you select one for the Winmodem. Highlight the first or lowest one and then click **OK**. Be sure to write the number of the free COM port you select. See the troubleshooting section of this manual if the software does not locate an available COM port.

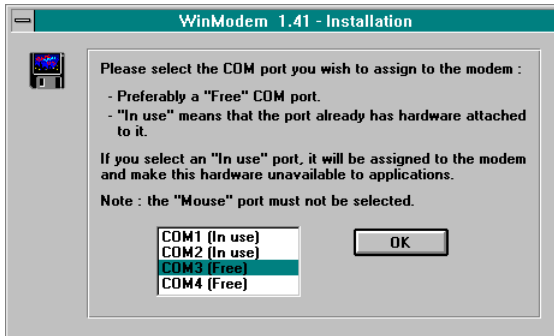

9. Your Winmodem software has been installed. Click **Restart Windows** to finish the process.



WINMODEM INSTALLATION UNDER WINDOWS 3.X

- Windows will now restart. At this point, you will see a new **Winmodem** group.



(Note: If you do not see a new Winmodem group, you will instead see the Configuration screen. You will have to choose an available I/O address and an available IRQ. Do not select "Let plug and play configure...")

- For the I/O address: Choose any on the list.
- For the IRQ: The COM port/IRQ combinations shown here work with most computer set-ups:

<u>COM</u>	<u>IRQ</u>
14
23
35, 7, or 9
45, 7, or 9

WINMODEM INSTALLATION UNDER WINDOWS 3.X

- If you have a sound card, SCSI card, or game card, it might be using IRQ 5 or 7. Do not make 5 or 7 your first choice, because it might not be available.
- Once you've chosen a combination, restart Windows. Click on **Program Manager**. You should see the **Winmodem** group. If you do not see this group, try a different combination of resources.
- If you chose an unavailable I/O address, you will get an error message. Choose another I/O address in the **Configuration** dialog box that appears.
- If you chose an unavailable IRQ, you may encounter problems when your communications software program tells you it cannot find the modem. At that point choose another IRQ in the **Configuration** dialog box. (You can find it by clicking the **Configurator** icon in the **Winmodem** group in the **Program Manager** window.)

Once you've finished installing your modem, you are ready to install the *Connections CD-ROM* (included with your Winmodem.) Please turn to the section entitled "Software Installation"(page 29).

BEFORE YOU BEGIN (WINDOWS 95 USERS)

Your U.S. Robotics modem is a Plug and Play device. Windows 95 can automatically identify a Plug and Play device and determine if your system has the resources necessary to support the device. However, Plug and Play will not work if you do not have resources available or if devices on your system are not reporting resource usage correctly. Here's how you can verify that your system has the necessary resources before installing the modem.

1. Click the Windows 95 **Start** button, point to **Settings**, and then click **Control Panel**.
2. Double-click the **System** icon.
3. When the "System Properties" screen appears, click the **Device Manager** tab.

4. Double-click **Computer** and the "Computer Properties" screen appears. Select the option at the top of the screen to show Interrupt Requests (IRQs).

You will see the IRQs your system is currently using. If IRQs 3, 4, 5, and 7 are being used, you need to free an IRQ before you begin installation. This process involves moving a device from the IRQ you want to use to a different (and usually higher) IRQ setting. Please read the documentation for (or contact the manufacturer of) the device that is currently using the IRQ you want to use for your modem to learn more about what you should do to free the IRQ for your modem.

WINDOWS 95 INSTALLATION

You'll need these items from your U.S. Robotics modem box:

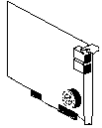

the modem



a phone cord



the Connections CD

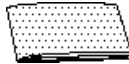

this manual



Winmodem disk



Installation Guide

Plus:  **a screwdriver** (*not included*)



NOTE: These instructions are for Windows 95 users. Windows 3.x users should go to the "Windows 3.x Installation" section of this manual on [page 3](#).

How to Prepare for Plug and Play Installation

Checking Your Version of Windows 95

To install your Winmodem properly, you must first know which version of Windows 95 you have. Please follow these instructions to check.

WINMODEM INSTALLATION UNDER WINDOWS 95

1. Right-click the **My Computer** icon in Windows.



2. Select **Properties**.

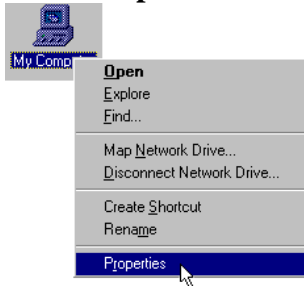

3. Find your version number in the upper right corner of the “General” screen shown below.

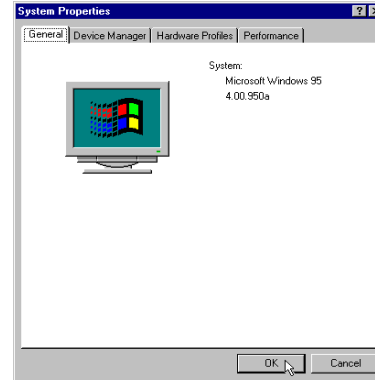

In this example the Windows version is 950a.

Make a note of the version you are have. You will follow different instructions later depending on which version you have.

Check Your System's Resources

Your modem is a Plug and Play device. Windows 95 can automatically identify a Plug and Play device and determine if your system has the resources necessary to support the device. However, Plug and Play will not work if you do not have resources available or if devices on your system are not reporting resource usage correctly. Here's how you can verify that your system has the necessary resources before installing the modem.

1. Click the Windows 95 **Start** button, point to **Settings**, and then click **Control Panel**.
2. Double-click the **System** icon.
3. When the "System Properties" screen appears, click the **Device Manager** tab.
4. Double-click **Computer** and the "Computer Properties" screen appears.

5. Select the **Interrupt request (IRQ)** option at the top of the screen.

You will see the IRQs your system is currently using. If IRQs 3, 4, 5, and 7 are being used, you need to free an IRQ before you begin installation. This process involves moving a device from the IRQ you want to use to a different (and usually higher) IRQ setting. Please read the documentation for (or contact the manufacturer of) the device that is currently using the IRQ you want to use for your modem to learn more about what you should do to free the IRQ for your modem.

How to Insert the Modem



NOTE: Before installing your modem, write down its serial number. (You'll find the serial number underneath the bar code on the white sticker on the modem and on the outside of the box the modem came in.) If you ever need to call our customer support department, a customer support representative will ask you for the serial number. This will help him or her identify your modem.

1. Shut down windows.
2. Turn off your computer and unplug it from the electrical outlet.
3. Unplug any peripheral devices (printer, monitor, keyboard, mouse, etc.) from the computer.



TIP: Before you unplug anything, label the cords or make a sketch of how things are connected. This can be helpful when you plug things back in later.



CAUTION : To avoid risk of electric shock, make sure your computer and all peripheral devices are turned off and unplugged from electrical outlets.

4. Remove the screws from your computer's cover and then remove the cover. Your computer may look different from the drawing on the [next page](#), but the basic principle for removing the cover should be the same. Refer to your computer manufacturer's manual if you need further instructions.

WINMODEM INSTALLATION UNDER WINDOWS 95

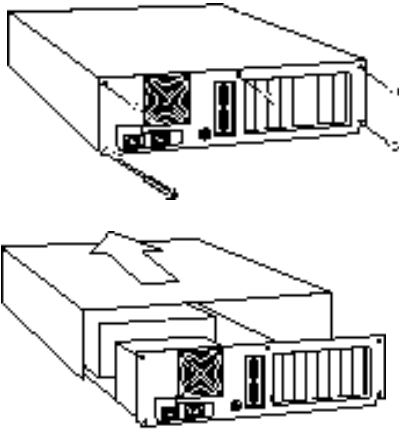

5. Find an empty ISA expansion slot that's at least as long as the gold edge of your modem. (ISA slots are black plastic grooves lined with metal.) Unscrew and remove the expansion slot cover (the long narrow piece of metal that keeps dust from entering through the opening that's perpendicular to the slot). Be careful not to

drop the screw into the computer, you will need it later to screw the modem into place.

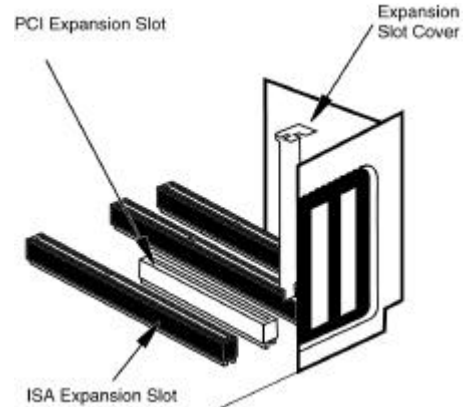

6. Holding the modem by each corner, align the gold edge with an empty expansion slot. Push down gently until the modem snaps into the slot.



NOTE: The diagram on the below shows horizontally aligned expansion slots. Some computers have vertically aligned slots. The instructions apply to both styles.

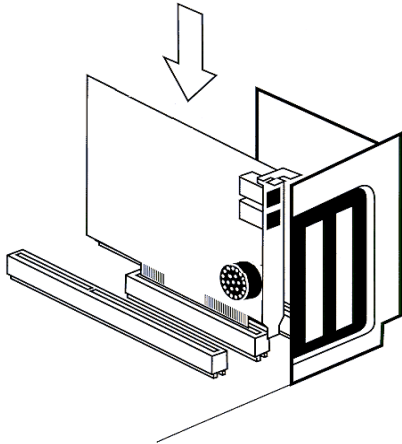

You'll have to apply a little pressure to seat the modem properly. Sometimes a gentle back-and-forth motion helps get the modem all the way into the slot. If you feel resistance, the modem may not be properly lined up with the slot. **Do not force it.** Take the modem all the way out and try again.

7. Once the modem is in the slot, secure it using the screw you removed in step 5.
8. Put the computer's cover back on and replace the screws.
9. Locate the wall jack you plan to use for the modem. If you have a phone plugged into this jack, disconnect the phone's cord from the jack.
10. Plug one end of the phone cord included with the modem into the TELCO jack at the rear of the modem. Plug the other end of the cable into the wall jack.

WINMODEM INSTALLATION UNDER WINDOWS 95

11. If you wish to use a phone through the same phone wall jack as the modem when the modem is not in use, plug your phone's cord into the modem's PHONE jack.

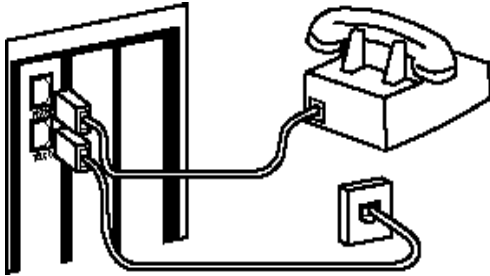

12. Plug the power cords, cables, and peripherals back into the computer and turn the computer on.



WARNING : The phone jack you use must be an **ANALOG** phone line (the type found in most homes). Many office buildings have digital phone lines. Be sure you know which type of line you have. The modem will be damaged if you use a digital phone line.

13. Once Windows starts, you will see a series of screens indicating new hardware has been installed. At this point you will install Winmodem software.

If you have Windows 95 version 950b, go to [page 22](#) of this manual.

If you have Windows 95 version 950 or 950a, continue with the instructions on the [next page](#).

Installing the Winmodem Software in Windows 950 or 950a

1. This screen will come up when Windows restarts. If the **Driver from disk...** option is not already selected, select it now. Click **OK** to continue.

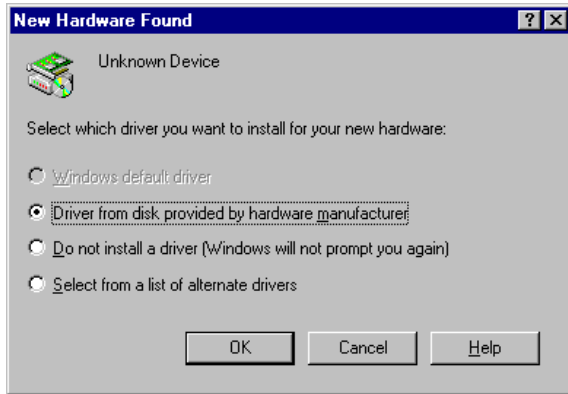

2. When you see this screen, insert the Winmodem floppy disk (which came with your Winmodem) and click **OK**.

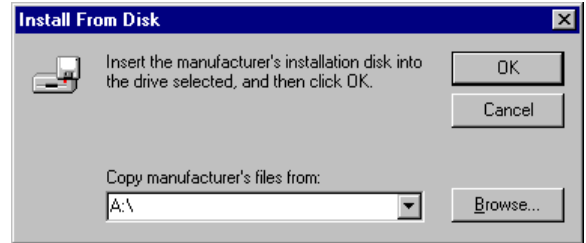

3. You will see a screen confirming that you are installing a Winmodem. When the screen finishes building your drivers, remove the Winmodem disk. The screen shown on the next screen tells you which COM port your Winmodem has been installed.

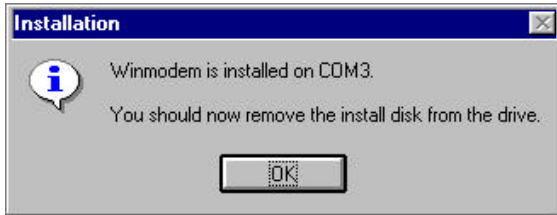

4. Make a note of the COM port and then click **OK**. You may need this information when installing communications software.
5. To check your installation go to steps 8 through 10 starting on [page 25](#) of this manual. You are now ready to install the *Connections* CD-ROM (included with your Winmodem). Go to “Software Installation and Testing” on [page 29](#) for instructions on installing the *Connections* CD and trying out your modem by registering online.

Installing the Winmodem Software in Windows 950b

1. When you see this screen after Windows starts, **DO NOT** click anything **DO NOT** press **ENTER**.



Instead, insert your Winmodem disk in your floppy drive.

WINMODEM INSTALLATION UNDER WINDOWS 95

2. Then click **Next** to continue.



3. When you see this screen, click **Finish**.

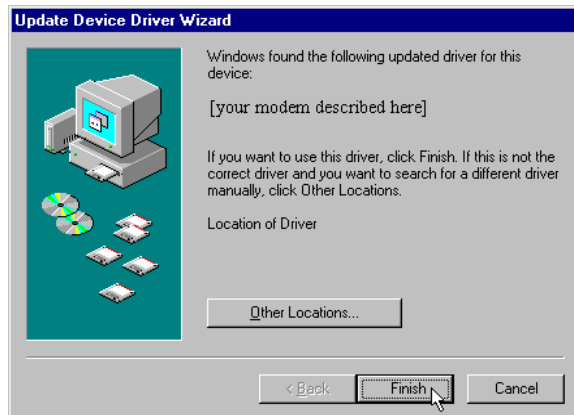

WINMODEM INSTALLATION UNDER WINDOWS 95



NOTE: If you see the screen below instead of the screen preceding, click the **Back** button.



4. When you see this screen, click **OK**.

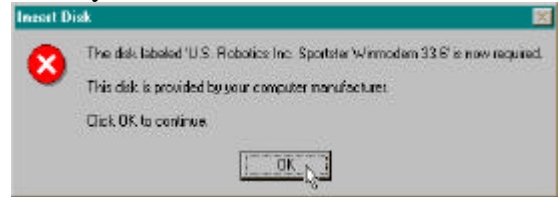

5. When you see this screen, type **A:\.** (Be sure to type the period after the backslash) to replace whatever is in the **Copy files from** box.

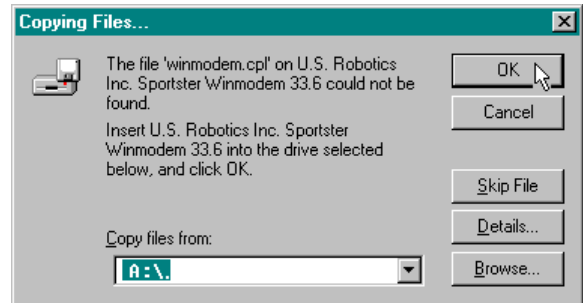

WINMODEM INSTALLATION UNDER WINDOWS 95

6. Then click **OK**. You will see a series of screens as files copy and drivers build.
7. Finally, you will see a screen telling you that the modem has been installed. Click **OK**.
8. Check the installation by going into the **Control Panel**.

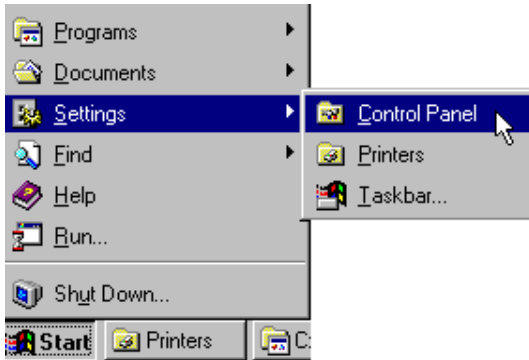

9. Double-click the **Modem** icon. (circled in the screen below.)

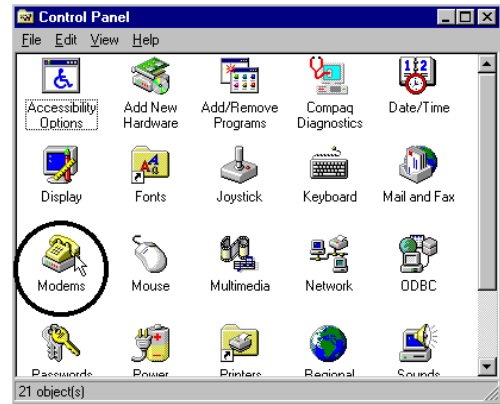

10. You should then see this screen. Click **OK**.

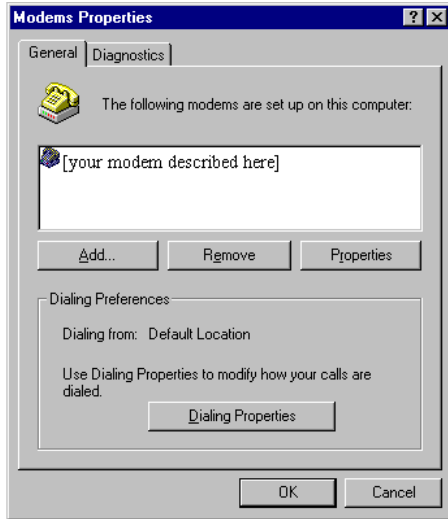

11. For instructions on how to install the RapidComm fax/data software, go to the section entitled “Software Installation and Testing” ([page 29](#)).

Un-installing the Winmodem Software.

1. From the **Start** menu, point to **Settings** and then click **Control Panel**.

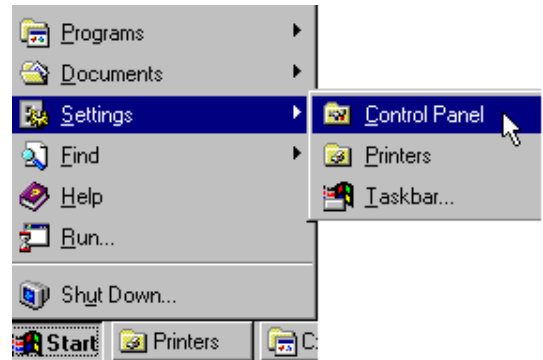

WINMODEM INSTALLATION UNDER WINDOWS 95

2. Double click the **Modem** icon (circled below) and then click on your Winmodem. Click on the **Properties** button.

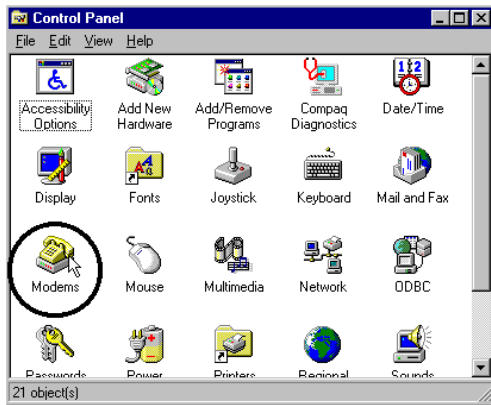

3. Choose the "Port Settings" tab and click the **Uninstall** button.

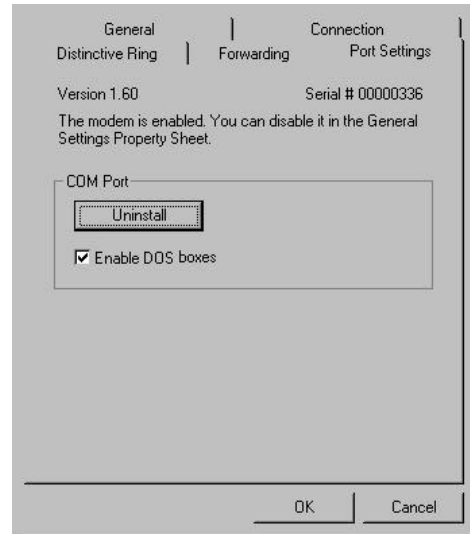

WINMODEM INSTALLATION UNDER WINDOWS 95

To verify that you uninstalled your Winmodem begin at the **Start** menu and select **Control Panel**. Double-click on the **System** icon then select the **Device Manager** tab. If there is no modem icon present you've successfully uninstalled your Winmodem.

4. If you uninstalled your Winmodem software due to a failed installation, please return to the section entitled "Installing the Winmodem Software under Windows 950 or 950a" ([page 21](#)) or the section entitled "Installing the Winmodem Software under Windows 950b" ([page 22](#)). If you are not sure which version of Windows 95 you are using, please refer to the section entitled "Checking your Version of Windows 95" ([page 14](#)).

SOFTWARE INSTALLATION AND TESTING

Software Installation and Registration Using the Setup Wizard

This section tells you how to start the U.S. Robotics Setup Wizard on the *Connections*[™] CD.

The SetUp Wizard will guide you through installing software off the CD and testing your modem by registering it online.

Once you've followed this section's instructions to start the Wizard, simply follow the Wizard's on-screen instructions.

NOTE: The following instructions apply to Windows 3.x and Windows 95 users. However, only Windows 95 screens are shown.

NOTE: If you have an older version of RapidComm installed on your system, **uninstall it before continuing.**

Starting the Wizard

1. From the Windows 95 desktop, click the **Start** button and then click **Run**.

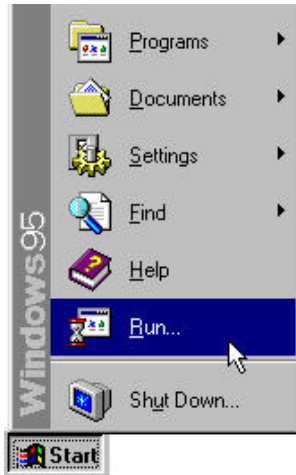

2. In the text box, type **D:\setup.exe**. (If your CD-ROM drive has a letter name other than **D**, type that letter in place of **D**.)

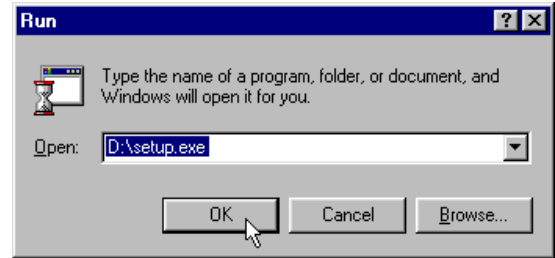

3. Click **OK**.
3. Follow the on-screen instructions to run the Wizard.

After running the Wizard, you'll be given the option to explore other areas of the *Connections* CD.

You can also use the CD later. To start the CD, click the Windows **Start** menu, point to **Programs**, point to **U.S. Robotics Connections**, and then click **Connections**.

Installing the RapidComm™ Fax/Data Software

The Connections CD contains the RapidComm fax/data communications program. You can use this program to transfer faxes and data files to a remote modem.

Once you've run the Set-Up Wizard, you can install RapidComm (The Set-Up Wizard does not install RapidComm.)

To install RapidComm insert the *Connections CD* and double click on the CD-Rom icon. Click on the **Business and Productivity**

Section. Now double click the RapidComm icon and then double click on the RapidComm icon.

The CD also contains an electronic user's guide for RapidComm. You can install this guide by clicking on the **User's Guide** icon located next to the RapidComm icon. Once you click on the **Users Guide** icon, the RapidComm User's Guide will automatically be installed on to our hard drive. You can access the information within this User's Guide from the Help menu.

Congratulations —you are now ready to start using your U.S. Robotics Winmodem!

INSTALLING OTHER FAX/DATA SOFTWARE

You can use any other Windows based fax/data software other than RapidComm. (the fax/data software on the *Connections* CD). Your modem was designed for and tested using a wide range of communications software packages. This section will guide you through some of the details you may need to know when installing other communications software packages.

Type of Modem

Most communications software programs will ask you to select the type of modem you are using. Select a *U.S. Robotics Sportster high speed modem*. If that selection is not listed, pick *Courier Dual Standard, V.32bis, or V.34*.

KEY POINT: Refer to your software manual for the program's installation instructions. The software's installation program will ask you questions about the modem you are using.

Initialization String

For hardware flow control, a fixed serial port rate and full result codes, type **AT&F1** and press **ENTER**. If you must use software flow control, type **AT&F2** and press **ENTER**.

 **NOTE:** If you use the Modem Station program to configure your modem, you must use **ATZ** for the initialization string.

Flow Control

- For hardware flow control (highly recommended), select **RTS/CTS**.
- For software flow control, select **XON/XOFF**.

 **NOTE:** You may need to disable the type of flow control (hardware or software) that you are not using.

 **NOTE:** DO NOT select a 28,800, 14,400, or 12,000 bps serial port rate, if offered. Your modem will NOT work correctly with any of these settings. Fix or lock the serial port (baud) rate (if it's referred to as autobaud, select OFF).

USING MODEM STATION

What Does Modem Station Do?

- ◆ Modem Station provides a simple to use interface that makes communicating with your modem easy.
- ◆ Modem Station allows you to point and click your way through configuration.
- ◆ Modem Station can automatically detect your modem and provide you with all the technical information you need, whenever you need it!

Why Modem Station?

- ◆ Modem commands can be confusing and difficult to memorize.
- ◆ Communications software often requires technical information about your modem.

- ◆ You may want to “tweak” your modem for optimum performance.

Installing Modem Station

If you did not install Modem Station when you first installed the *Connections* CD, please follow these instructions.

1. Insert the *Connections* CD into your CD-ROM drive.
2. Double-click the **My Computer** icon on your desktop.
3. Double-click the **CD-ROM** icon.
4. Double-click the **usrtools** folder.
5. Double-click the **umssetup** icon.

USING MODEM STATION

6. You will be asked whether you wish to install Modem Station. Click **Yes**.
7. Wait a few moments for the Installation Wizard to load.
8. After reading the information on the “Welcome” screen, click **Next**.



9. When you see this screen, click **Next** to accept the default directory or click **Browse** to change directories.

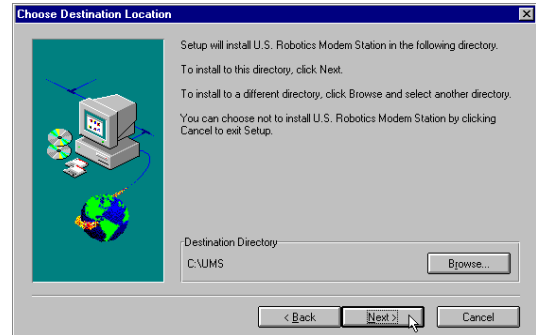

USING MODEM STATION

10. Click **Next** on the following screen to accept the default program folder. You can place Modem Station in an existing folder by selecting one from the list.

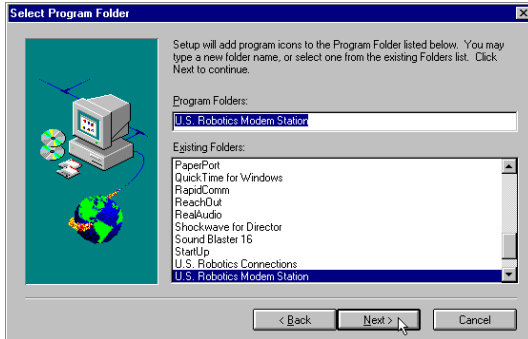

11. When you see the following screen, click **Finish** to complete the installation.

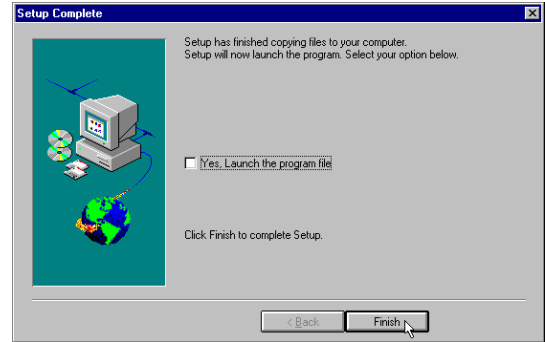

If this is the first time you've installed Modem Station, you may be asked to restart your computer.

USING MODEM STATION

Starting Modem Station

1. Click Windows **Start** button and then point to **Programs**. Click **U.S. Robotics Modem Station** (or the folder you selected during installation).
2. Click the **Modem Station** icon. This brings up the main menu.

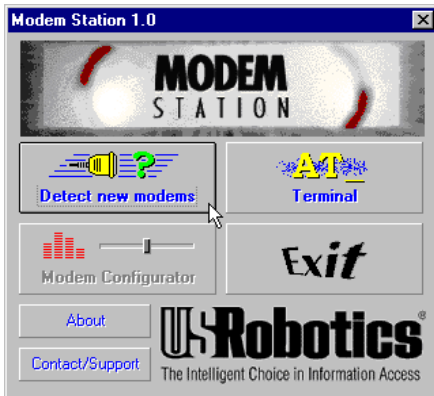

The main menu gives you direct access to the following options:

DETECT NEW MODEMS

This option detects US Robotics modems installed on your system and shows what COM port they are using. Click this option if you are running Modem Station for the first time, if you are changing modems, or if you simply need to know what port your modem is using.

TERMINAL

Terminal allows you to send commands directly to your modem and displays the responses. You can use Terminal to dial up BBSs. In addition, you can configure your modem using Terminal. However, it is much easier to use the Modem Configurator.

USING MODEM STATION

MODEM CONFIGURATOR

Modem Configurator provides an easy-to-use interface for entering hard-to-remember commands. Use Modem Configurator for troubleshooting, initial configuration, and tuning your modem for optimum performance. Using the options available in Modem Configurator, you can control nearly every aspect of your modem's performance. We will discuss Modem Configurator's options in more detail in later sections.

ABOUT

The About option provides copyright and version information.

CONTACT/SUPPORT

This option details how to get in touch with 3Com.



TIP: For your convenience, we provide many on-line support avenues. For specific questions, our fax-on-demand service is a good place to start. You can download FAQs, software, and help files from our Web sites and BBS, or receive individualized support via support@usr.com. Type 0000 (4 zeroes) in the subject line of your e-mail.

USING MODEM STATION

Using Detect New Modems

1. Click **Detect New Modems** to bring up the following screen.

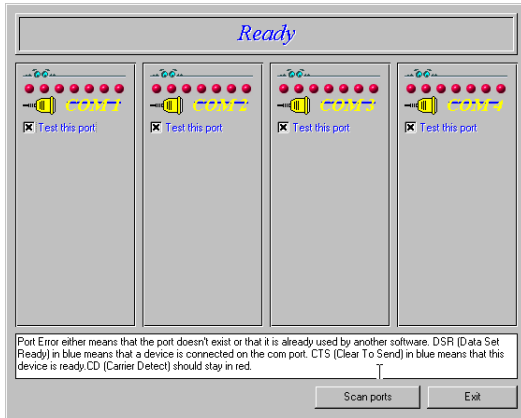

The screen consists of four columns, one for each possible COM port on a PC. You can scan a specific port(s) by selecting the checkbox for that port.

2. Click **Scan** to have Modem Station check for installed modems. This may take a few moments.
3. When the scan finishes, you will see the following display. Your display may differ depending on the type and number of modems installed.

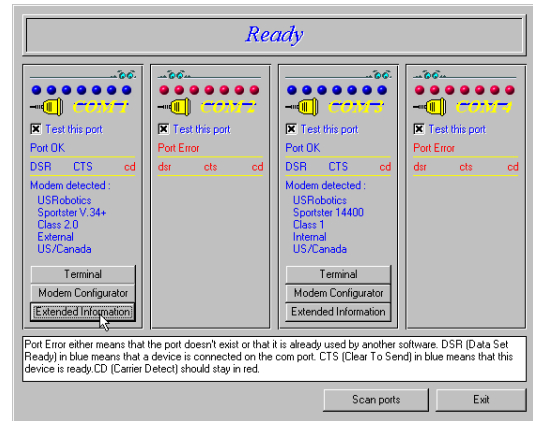

If your modem is installed and configured correctly, Modem Station will find the

USING MODEM STATION

modem and display make and model information under the assigned port. All currently active ports should display “Port OK” under the heading. If a port displays a “Port Error”, it usually means that the port is disabled in system setup.



NOTE: Different systems and BIOSes use different methods of disabling COM ports. As a result, we cannot provide support for disabling/enabling COM ports. Please refer to your system’s documentation or contact the manufacturer of your system for further information.

If you look at the information for the port your modem is using, you will see three buttons. These allow you to access Terminal and

Modem Configurator without going back to the main menu. Extended Information provides detailed information about your modem, previous connections, firmware dates, etc. This next section details using the Terminal option.

Using Terminal

You can access Terminal from either the **Main** menu or the “Detect New Modems” screen. Clicking **Terminal** brings up the “Terminal” window.

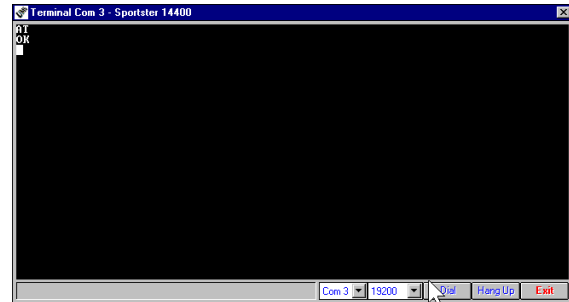

USING MODEM STATION

In addition to allowing direct entry of modem commands, the “Terminal” window also allows you to dial into Bulletin Boards, listing services, and other online services.

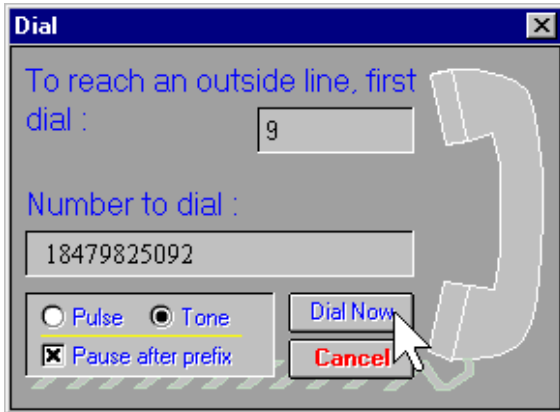

 **NOTE: Modem Station's Terminal window is provided primarily for troubleshooting convenience. If you frequently use BBSs, you will probably want to use a separate, full-featured Terminal program such as that provided in our RapidComm software.**

On the lower part of the Terminal screen, you will see the COM port your modem is currently using. To select another modem, simply click on the arrow and select that modem's assigned port.

USING MODEM STATION

To the right of the port settings are the port speed settings. Port speed is the speed at which your computer sends data to the modem. We will discuss port speed settings in detail later in this section.

Terminal includes a basic auto dialer.

To have Terminal dial a number for you, click **Dial** to bring up the “Dial” screen.

You need to tell the Dialer a few things about your phone system, such as whether it uses tone or pulse dialing, what digit, if any, you need to dial to get an outside line, and whether the dialer should wait between dialing that digit and the rest of the number. Once you provide this information, simply enter the phone number as if you were dialing a telephone. Click **Dial Now** to dial the number.

You can end a call by clicking **Hang Up** at the bottom of the screen.

When you are finished using Terminal, click **Exit** to return to the screen you accessed it from.

USING MODEM STATION

Using Modem Configurator

You can access Modem Configurator from either the **Main** menu or the *Detect New Modems* screen.

Click **Modem Configurator** to bring up this menu.

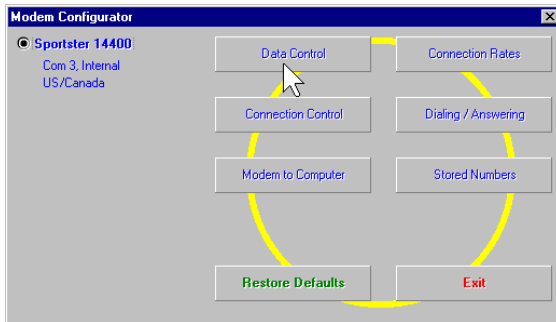

The **Modem Configurator** menu gives you access to the following options:

Data Control

This is the “Data Control” screen.

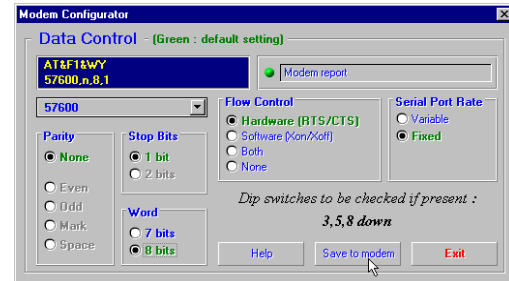

The “Data Control” screen allows you to assign the following basic communications settings:

- ◆ PORT SPEED
- ◆ PARITY
- ◆ STOP BITS
- ◆ WORD LENGTH
- ◆ FLOW CONTROL
- ◆ SERIAL PORT RATE

USING MODEM STATION

For information on using these settings, please refer to the “Glossary” at the back of this manual.

Click **Help** for quick definitions of the terminology used in this screen.

In the upper left-hand corner of the screen, you will see the data control commands currently in use.

Once you have entered the Data Control settings, click **Save to Modem**. This stores the settings so that you do not have to re-enter them.

This screen also displays the default DIP switch settings.



TECHNICAL STUFF: DIP switches are tiny switches that control a few basic functions on some external modems. On modems without DIP switches, these functions are handled by modem commands.

Click **Exit** to return to the **Modem Configurator** menu.

CONNECTION CONTROL

This is where you adjust your modem’s connection and transmission settings.

USING MODEM STATION

Click **Connection Control** to bring up this screen.

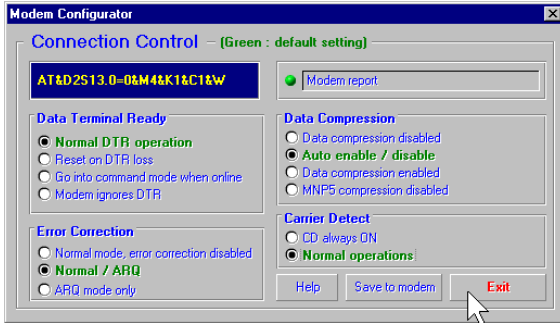

In the upper left hand corner of this screen, you will find the current Connection Control settings.

Use the “Connections Control” screen to configure the following settings:

- ◆ DATA TERMINAL READY (DTR)
- ◆ ERROR CORRECTION
- ◆ DATA COMPRESSION
- ◆ CARRIER DETECT

For detailed information about these settings, refer to the “Glossary” or the “Technical Quick Reference” sections of this manual.

 **TIP:** On external modems, receiving a Data Terminal Ready signal from the PC causes the TR light to light up.

Click **Help** for quick definitions of terminology used in this screen.

USING MODEM STATION

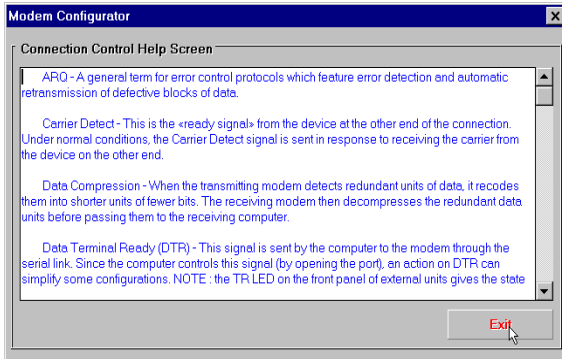

Once you have configured your Connection Control settings, click **Save to Modem** to save your settings.

Using Modem to Computer

These settings control how your modem and computer communicate with each other. They control what you see on your terminal screen and how results are displayed.

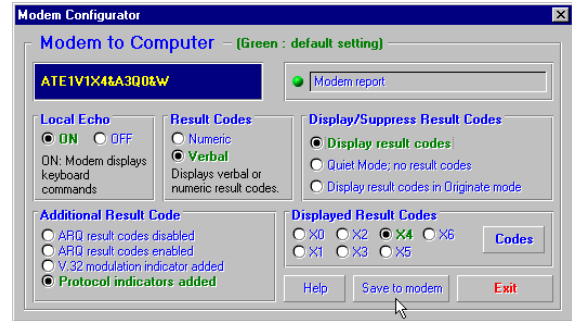

If you look in the upper left hand corner of the display, you will see the commands currently in use.

The “Modem to Computer” screen allows you to configure the following settings:

- ◆ LOCAL ECHO
- ◆ RESULT CODES
- ◆ RESULT CODE PREFERENCES

USING MODEM STATION



TIP: If you type ATDT and see 'AATDDTT' on your screen, it is possible that both your software and modem have Local Echo set to 'ON'. Turn Local Echo 'OFF' on EITHER the modem or the software to solve this problem.

For details on using the commands in this screen, refer to the "Glossary" or "Technical Quick Reference" sections of this manual.

Click **Help** to see quick definitions of terminology used in this screen.

This screen also includes a chart of the ways result codes can be displayed. Click **Codes** to view a chart of the display options.

Once you configure your settings, click **Save to Modem** to save your choices.

CONNECTION RATES

The "Connection Rates" screen allows you to configure modem speeds and protocols.



WARNING! Use caution when changing connection settings. Improper settings may cause your modem to function incorrectly, disconnect, or fail to connect at all.

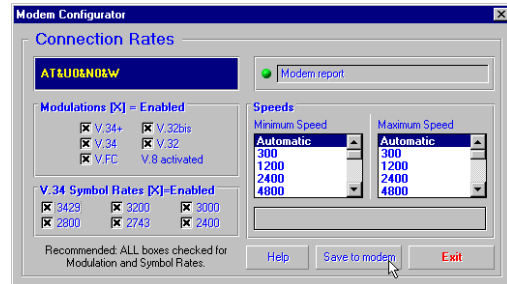

In the upper left hand corner of the screen you will see the current connection commands.

USING MODEM STATION

This screen allows you to configure the following settings:

- ◆ MODULATIONS
- ◆ V.34 SYMBOL RATES
- ◆ SPEEDS

Again, once you have selected your settings, click **Save to Modem** to save them.

When you are finished, click **Exit** to return to the **Modem Configurator** menu.

Please refer to the main body of the manual and the “Glossary” for detailed information about the terminology and settings used in this screen.

Click **Help** for quick definitions of terminology used in this screen.

DIALING/ANSWERING

The next screen allows you to adjust how your modem initiates and receives calls.

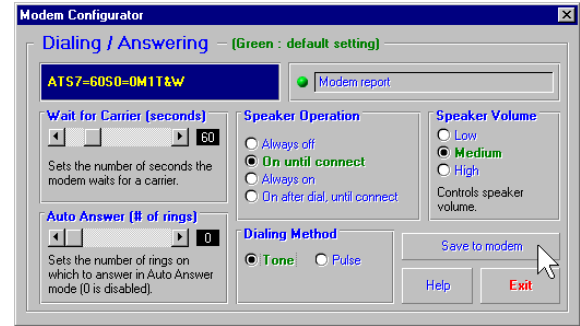

Using this screen, you can configure the following dial settings:

- ◆ WAIT FOR CARRIER
- ◆ AUTO-ANSWER # OF RINGS
- ◆ SPEAKER OPERATION
- ◆ DIALING METHOD
- ◆ SPEAKER VOLUME

USING MODEM STATION

STORED NUMBERS

The “Stored Numbers” screen displays the phone numbers currently stored in your modem’s memory.

Use this screen to edit or add numbers stored in the modem’s memory.

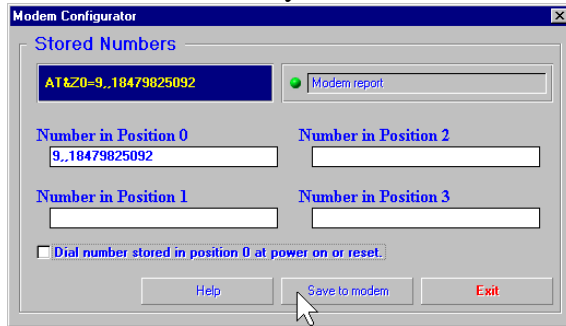

To store a number in your modem’s memory, simply click in one of the entry boxes. Type in the phone number exactly as you would dial it. Position Zero has a special feature. You can set your modem to automatically dial this

number when your computer is turned on or when it is reset. This is very useful if you are using your modem with a “dumb terminal” or know that you need to connect to a specific bulletin board or listing service.

You can change stored numbers by highlighting them and then typing the new numbers in their place. Once you store your numbers, you can dial them by entering a single command from Terminal Mode:

(for example: **ATDS0**, **ATDS1**, or **ATDS2**).

Your U.S. Robotics modem comes with one phone number already stored in Position 0. If you haven’t changed the default, typing **ATDS0** will automatically dial the 3Com BBS.

Once you enter the numbers you wish to store, click **Save to Modem** to store them. Click **Exit** to return to the **Main** menu.

USING MODEM STATION

The last option, Restore Defaults, resets your modem to factory specifications. This option is available from many of the screens within Modem Station.



TIP: Restore Defaults will set your modem back to factory specifications. It is a good place to start when troubleshooting.

Using the Extended Information Screens

The “Extended Information” screens provide important and useful information about your modem.

We devote a separate section to the Extended Information screens so that we can explain what you’ll see (and why it is important to you)

as fully as possible.

There are a series of commands used to obtain detailed information from U.S. Robotics modems. Extended Information provides a convenient way to get that important information without memorizing the commands.

From the “Detect New Modems” screen, click **Extended Information**.

The “Extended Information” screen provides access to the following information about your modem:

- ◆ ROM CHECKSUM
- ◆ PRODUCT
- ◆ ACTIVE PROFILE
- ◆ STORED PROFILE
- ◆ CONFIGURATION PROFILE
- ◆ LINK DIAGNOSTICS
- ◆ VxD CONFIGURATION
- ◆ DIAL/SECURITY

USING MODEM STATION

Winmodem users will have access to VxD information via these screens.

Courier users will have access to Dial/Security information.

Click **ROM Checksum** to bring up the following screen.

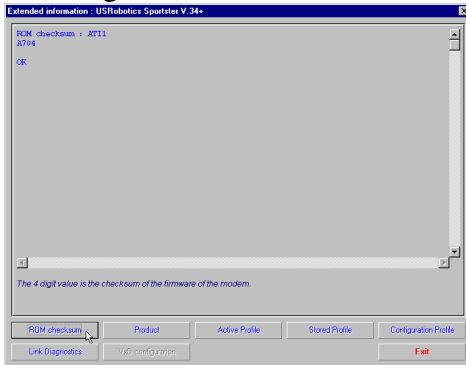

Technicians use the ROM Checksum to verify information stored in the modem's Read Only Memory. For information about the specific

modem you are using, click **Product** to bring up the next screen.

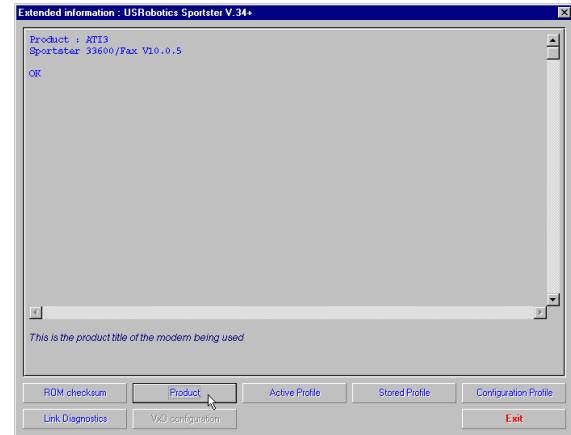

The "Product" screen displays the make and model of your modem.

Your modem is able to store two configurations or "profiles." Only one can be active at any time.

USING MODEM STATION

To see information about the profile in use, click **Active Profile** to bring up the next screen.

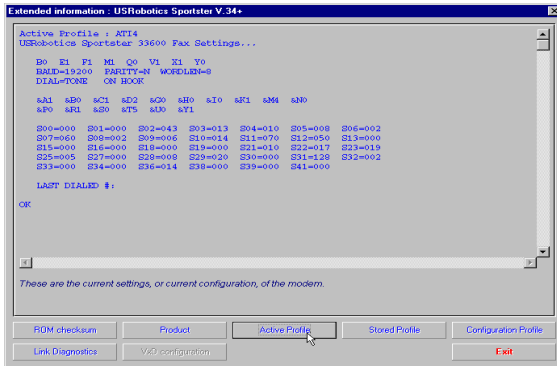

This screen contains information about your modem's current configuration. Starting from the top, you will see the make and model of your modem. Directly below that, you will see basic commands currently in use followed by the current connection settings.

The two lines below the connection settings are the advanced commands currently in use. Below them is a display of the contents of the 'S-Registers' for your modem. These registers are special programmable areas of your modem's memory. They are used to store commands that are too complex to be handled by the standard (or 'AT') commands. Just below that you will see the last number dialed.

The next option displays the "Stored Profile" screen. This screen shows the configuration stored in your modem's NVRAM (special programmable memory). Note that any stored phone numbers are displayed on this screen as well.

The next two screens contain information that our technical support representatives may need if you request support.

USING MODEM STATION

Click **Configuration** to bring up the first of these screens.

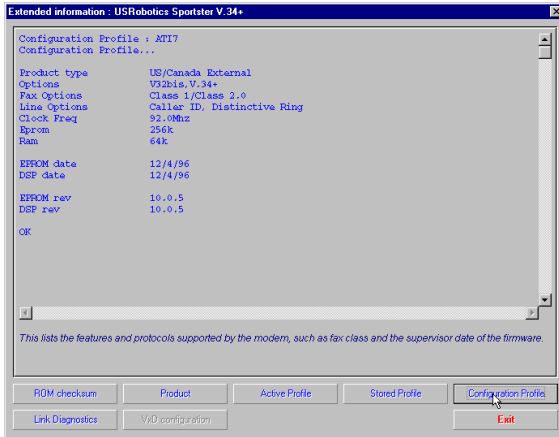

- *Options* displays the protocols available to your modem.
- *Fax Options* displays your fax compatibility.
- *Clock Frequency* displays the speed of the tiny “clock” that controls the timing of operations within the modem.
- *EPROM* displays how much information can be stored in the EPROM (or Supervisor) chip.
- *RAM* displays how much memory your modem has for processing commands and internal functions.

The “Configuration” screen displays the following information about your modem.

- *Product Type* displays the information relating to the make and model of your modem.

USING MODEM STATION

- *Supervisor Date* (or EPROM Date) displays the version date of the ‘firmware’ stored in the Supervisor chip. (The Supervisor chip contains the special software used to control your modem’s functions.) If a support representative asks you for your Supervisor or EPROM date, look here.
- *DSP Date* is the date of the ‘firmware’ that controls the DSP in your modem.
- *Supervisor and DSP rev* (or revisions) are the equivalent of software version numbers.
- *DAA Country* displays the countries your modem is designed for. This is important because phone systems and telecommunications laws vary from country to country.

Click **Link Diagnostics** to bring up the “Link Diagnostics” screen.

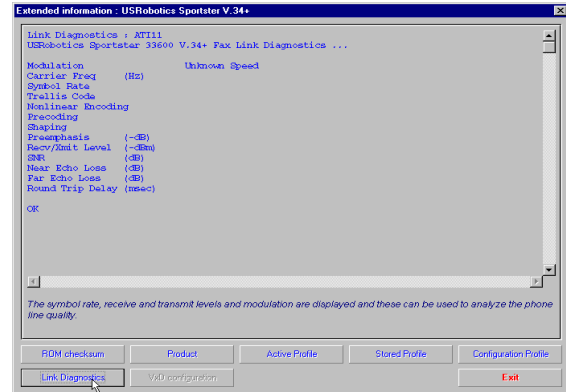

The “Link Diagnostics” screen displays statistics about your last connection. This screen is most often used as an aid in diagnosing connection failures, but it also can provide information about connection speeds and phone line conditions.

- *Modulation* displays the speed and type of connection.
- *Carrier Frequency* displays the electrical frequency of the carrier signal.

USING MODEM STATION

- *Symbol Rate* displays the speed of the transmission.
- *Trellis Code, Nonlinear Encoding, Shaping, and Precoding* all refer to methods of handling high speed data transmission.
- The items followed by *(dB)*, *(-dB)*, *(-dBm)*, and *(msec)* refer to variations in the modulation tones that actually carry the information.

The rest of the screen contains information about CRC errors, Block Errors (Blers), resent data, and other data. This information is very important if you experience problems transmitting or receiving data or if you suspect problems with your phone service.

If you are having connection problems, go directly to this screen to get this information. If you save anything to the modem between the last connection and this screen, the modem will not save these settings.

Only our U.S. Robotics Winmodems use VxDs, or Virtual Device Drivers. The Winmodem uses special software (called a 'driver') to manage many of the functions handled by hardware in our other modems. The Extended Information menu will offer you the option of clicking on *VxD* to view information on the Winmodem driver.

Courier users will see a display of current Dialback/Security settings. Refer to your Courier documentation for instructions on configuring these special features.

U.S. ROBOTICS MODEM UPDATE WIZARD

The *Connections* CD-ROM, which came with your modem, includes the U.S. Robotics Modem Update Wizard. This software is designed to quickly update your modem to the latest code.



NOTE: You can also obtain this software from our BBS (847-982-5092) or from our World Wide Web page (<http://www.3Com.com/56k>).



NOTE: Complete the instructions in the “Software Installation” chapter (starting on [page 29](#)) before installing the Modem Update Wizard.



NOTE: The following instructions apply to Windows 3.x and Windows 95 users. However, only Windows 95 screens are shown.

U.S. ROBOTICS MODEM UPDATE WIZARD

Installing the Wizard

1. Insert the *Connections* CD into your CD-ROM drive.
2. Click **Start** and point to **Programs**.
3. Point to **U.S. Robotics Connections**.
4. Click **Connections**.

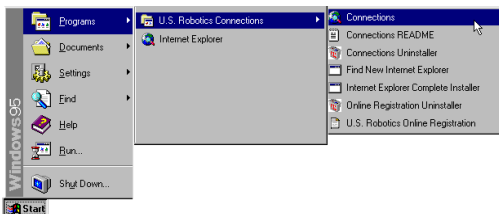

5. From the main **Connections** menu, click the **Customer Support** button.
6. Click the **Modem Update Wizard** button.
7. Follow the on-screen instructions to complete the installation.

8. When you see the screen below, the setup is complete. Click **OK**.

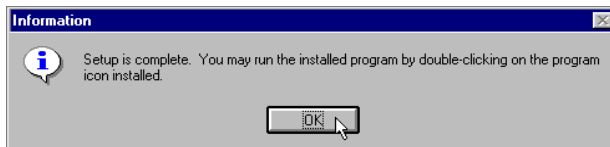

NOTE: For more detailed instructions, see our World Wide Web page (<http://www.3Com.com/56k>).

Updating Your Modem

1. Click **Start**. Point to **Programs**. Then point to **U.S. Robotics Modem Update Wizard**. Finally, point to the **Modem Update Wizard** selection.
2. Follow the on-screen instructions to complete the update process.

TROUBLESHOOTING AND ONLINE HELP RESOURCES

PROBLEM:

The modem displays double characters on your monitor.

Diagnosis:

The software's local echo setting is probably turned on.

Possible Solution:

Disable Local Echo in your software OR on your modem (not both). You can turn the local echo off on the modem by typing **ATE0** and then pressing **ENTER** in your software's terminal mode. To turn the local echo setting off in the software, refer to its documentation.

PROBLEM:

The modem won't go off hook to dial or doesn't answer the phone.

Diagnosis:

You may have plugged your modem's phone cord into a digital line.

Possible Solution:

Plugging your modem's phone cord into a digital phone line can damage the modem. Call your phone company if you are unsure whether or not your phone line is digital.

TROUBLESHOOTING AND ONLINE HELP RESOURCES

Diagnosis:

You may have plugged your modem's phone cord into the wrong jack on the modem.

Possible Solution:

Make sure the phone cord is plugged into a jack labeled with the word TELCO or a wall plug icon.

Diagnosis:

You might have a bad phone cord connection to your modem.

Possible Solution:

The phone cord should be plugged into the TELCO jack on the modem and the wall phone jack. The phone cord should be no longer than 12 feet in length. Use the phone cord included in your U.S. Robotics box if possible.

Diagnosis:

The phone jack may have been wired incorrectly.

Possible Solution:

Contact the telephone company. Ask them to make sure the tip and ring are on the inside pair of wires.

Diagnosis:

You may have devices between the modem and the phone jack.

Possible Solution:

There should be no line splitters, fax machines, or other devices between the modem and the wall jack.

Diagnosis:

You may have a poor line connection.

Possible Solution:

Place the call again. Calls are routed differently each time. To verify a valid phone connection, enter RapidComm's Terminal mode, type **ATX3DT18479825092** (the 3Com BBS), and press **ENTER**. If you are required to dial a 9 to get outside telephone access, make sure that you **include a 9 before** in the above number so you would instead type **ATX3DT918479825092**. This string bypasses the dial tone, allowing a connection if the modem is functioning properly.

PROBLEM:

Both modems sound like they exchange carrier signals but fail to establish a link.

Diagnosis:

You may have a poor line connection.

Possible Solution:

Try placing the call again. The phone company routes calls differently each time. To verify a valid phone connection, enter RapidComm's Terminal mode and type **ATX3DT18479825092** and press **ENTER** (the phone number is the 3Com BBS). Include a 9 in the above phone number (inserted immediately before the 1.) if you need to dial 9 to obtain outside phone access. This string bypasses the dial tone, allowing a connection if the modem is functioning properly.

TROUBLESHOOTING AND ONLINE HELP RESOURCES

Diagnosis:

The phone line might be wired incorrectly.

Possible Solution:

Contact the telephone company and ask them to make sure the tip and ring are on the inside pair of wires.

PROBLEM:

Your modem cannot achieve a 56K Internet connection.

Diagnosis:

Your modem is capable of receiving up to 56 Kbps and sending up to 31.2 Kbps. Due to FCC regulations, receiving speeds are limited to 53 Kbps. Actual speeds may vary. An analog phone line compatible with the 56K ITU standard or x2 technology, and an Internet provider or corporate host site

compatible with the 56K ITU standard or x2™ technology are necessary for these high-speed downloads.

Possible Solutions:

Check [http:// www.3com.com/56k](http://www.3com.com/56k) for a list of ISPs that observe the 56K ITU standard and/or offer x2 technology.

Call your phone company to find out if your phone line is compatible with the ITU-T standard for 56K and/ or is x2-compatible. You can also run the U.S. Robotics Line Test utility to determine if your line is compatible. To run the test, visit [http:// www.3com.com/56k](http://www.3com.com/56k)

PROBLEM:

Your modem won't connect at 2400 bps with a 2400 bps modem.

Diagnosis:

The modem you're trying to connect with could be an older model that doesn't support error control.

Possible Solution:

You can disable error control on your modem by typing **AT&M0** in terminal mode and pressing **ENTER**. Now try placing the call to the remote modem again. When finished, reset your modem to enable the error control features. In terminal mode, type **ATZ** and press **ENTER**.



NOTE: ATZ4 or AT&F1 are often the best reset strings, as they restore hardware flow control defaults.

PROBLEM:

Your screen keeps displaying random garbage characters.

Diagnosis:

You could have a conflict with the remote modem's settings for word length, parity, and stop bits.

TROUBLESHOOTING AND ONLINE HELP RESOURCES

Possible Solution:

Set your modem's word length, parity, and stop bits the same as the remote modem or BBS you are calling.

Diagnosis:

Your software and modem might not be set to the same flow control settings.

Possible Solution:

Make sure the software and modem have the same flow control settings (hardware [RTS/CTS] and software [xon/xoff]).

Diagnosis:

The best flow control settings might not be enabled on your modem.

Possible Solution:

In terminal mode, type **AT&F1** and press **ENTER** to set hardware flow control.

PROBLEM:

Your communications software is reporting many cyclic redundancy check (CRC) errors and low characters per second (CPS).

Diagnosis:

You may have a bad phone line.

Possible Solution:

Try placing the call again. The phone company routes calls differently each time.

TROUBLESHOOTING AND ONLINE HELP RESOURCES

Diagnosis:

Optimum flow control settings may not be enabled on your modem.

Possible Solution:

In terminal mode, type **AT&F1** and press **ENTER** to set hardware flow control.

Diagnosis:

Another software is running and conflicts between programs may be causing the CRC errors.

Possible Solution:

Close every program but the communications program.

Diagnosis:

The remote site you are dialing into may have trouble with the file transfer protocol.

Possible Solution:

Try using a different file transfer protocol. Do not use Xmodem if other protocols are available. Zmodem is the preferred protocol.

Diagnosis:

There may be a Terminate and Stay Resident (TSR) program (such as a screen saver or virus scanner) running in the background, disrupting data communications.

Possible Solution:

Disable any Terminate and Stay Resident (TSR) programs running in the background. If you have software running as a TSR, check the software's manual for information about disabling its ability to operate as a TSR.

Diagnosis:

You may be trying to download a file to a compressed area of your hard disk.

Possible Solution:

Download to an uncompressed area on your hard drive.

PROBLEM:

Errors are constantly occurring in your V.17 fax transmissions.

Diagnosis:

There may be a Terminate and Stay Resident (TSR) program (such as a screen saver or virus scanner) running in the background, disrupting data communications.

Possible Solution:

Disable any Terminate and Stay Resident (TSR) programs running in the background. If you have software running as a TSR, check the software's manual for information about disabling its ability to operate as a TSR.

Diagnosis:

Your baud rate may be set too high.

Possible Solution:

In your software program, lower the baud rate to 9600, 7200, or 4800.

Diagnosis:

You may be trying to fax a compressed file.

Possible Solution:

Open the file in the application in which it was created. Select RapidComm as the printer and then print the file.

PROBLEM:

RapidComm fails to initialize the modem.

Diagnosis:

RapidComm's port settings may be incorrect.

Possible Solution:

Make sure RapidComm's port settings are correctly set for your modem.



NOTE to users with an older versions of RapidComm on their systems: You must uninstall the older version before installing the most recent version (contained on the Connections CD-ROM that came with your new modem). Otherwise, system conflicts may hamper RapidComm's ability to work properly.

PROBLEM

Plug and Play does not detect your modem.

You've installed the modem and Windows has restarted, but you simply see your desktop. You do not see any screens indicating new hardware has been detected.

Diagnosis:

The Plug and Play installation was not successful.

TROUBLESHOOTING AND ONLINE HELP RESOURCES

Possible Solution:

Try the following:

1. Click Windows 95 **Start** and click **Shut Down**. When asked if you wish to shut down your computer, click **Yes**. When Windows 95 indicates that it is safe to turn off your computer, turn it off and wait 15 seconds. Then turn the computer back on. Windows 95 may detect your modem upon this restart even if it did not detect the modem during the initial installation. If you see screens indicating that new hardware has been detected by Windows 95, continue with Windows 95 installation on [page 15](#).

If you do not see the new hardware screens, continue with step 2.

2. Click Windows 95 **Start**, point to **Settings**, and click **Control Panel**. Double-click the **System** icon and then click the **Device Manager** tab on the “System Properties” screen. Look for “Other Devices” or “Unknown Devices” in the list that appears. If you do not see either of these options in the list, continue with the next section to learn about our support options. If you do see one of these options, double-click the option. If the description that appears matches the modem you are trying to install, click the **Remove** button. Click **OK** when Windows asks if you wish to remove the device. Next, restart the computer and continue with the instructions on [page 15](#).

TROUBLESHOOTING AND ONLINE HELP RESOURCES

If the computer does not detect the modem after this second restart, please continue reading this chapter for information about our support options.

Online Help Resources

Connecting to the 3Com BBS

To connect to the 3Com Bulletin Board System, follow these steps:

1. Start your fax/data communications program. The software settings for our BBS are:

ANSI terminal emulation

Data Bits: 8

Parity: None

Stop Bits: 1

2. Put the program in Terminal mode.
3. Type **ATDS0** (the last digit is a zero) and press **ENTER**.



NOTE: ATDS0 (the last digit is a zero) automatically dials 1-847-982-5092, the 3Com BBS.

If this is your first time connecting to our BBS, you will be asked to enter your name, create a password of your choice, and to fill out a questionnaire.

TROUBLESHOOTING AND ONLINE HELP RESOURCES

The introductory screen of the 3Com BBS will look like the screen shot below. The BBS gives you access to customer and technical support documents and the BBS library. The library contains hundreds of helpful files and tips to help simplify using your modem.

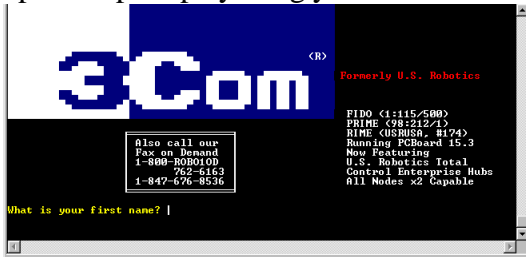

When you are ready to leave the BBS, type **G** (for “good-bye”) from the main menu.

3Com offers a number of other online technical support options. Choose any one of the following options for help with and/or more information on your new modem.

Internet FTP

Provides free library containing the same files as the BBS site. FTP to **ftp.usr.com**.

Internet on Demand

Provides automatic technical support through a library containing product information, quick reference cards, and installation help. To obtain an index of available documents, send a blank e-mail to **support@usr.com**. To have a specific document e-mailed to you, send the document's number in the subject field.

World Wide Web

A 3Com Web page containing the same information as the Internet on Demand listing.

Log on to:

<http://www.usr.com/home/online/>

CompuServe

Access the same information as the Internet FTP site. The 3Com forum address is **GO THREecom**. Address private messages to **76711,707**.

America Online

Connect to 3Com through America Online. Go to the **Keyword** field and type **3Com** to connect to various 3Com resources, such as file libraries, message boards, online customer support, and product announcements.

Customer Support via the Phone

Technical questions about 3Com modems can also be answered by technical support specialists.



NOTE: Before calling, please have the diagnostic program, **Modem Station**, installed on your system. The program is on the Connections CD that came with the modem. To install the program on your system, follow the instructions on the [following page](#).

TROUBLESHOOTING AND ONLINE HELP RESOURCES

1. Insert the *Connections* CD into your CD-ROM drive.
2. Double-click the **My Computer** icon on your desktop.
3. Double-click the CD-ROM icon.
4. Double-click the **usrtools** folder.
5. Double-click the **umssetup** icon.
6. Follow the on-screen instructions.

This program may help the specialist solve the problem quickly and shorten the cost of the call.

Regular Service

(847) 982-5151

8:00 am - 6:00 pm CST Monday - Friday.

Automated service is available 24 hours a day 7 days a week.

Priority, No-Hold Service

3Com also staffs its own fee-based 900 number for immediate assistance. These lines are staffed from 8a.m.- 10 p.m. Monday through Friday CST and 9 a.m.- 5 p.m. Saturday and Sunday CST. (Service available in the U.S. only. Hours subject to change without notice.)

No-Hold line 900-555-USR1

There will be a charge to your local phone bill. You must be 18 or older or have parental permission.

Are You Still Having Problems?

- Review this manual.
- Call or visit your modem dealer. They may be able to provide immediate assistance.

TROUBLESHOOTING AND ONLINE HELP RESOURCES

- If your dealer can't help you, contact 3Com Customer Support. When you call, specify your modem serial number (found on the modem and on the outside of the box), the software being used, and, if possible, have the contents of your ATI7 screen available.

If You Need to Return the Modem to 3Com for Repair

Contact 3Com Customer Support. If the support representative determines that you need to return the modem for repair, you will receive an SRO (Service Repair Order) number. You must have an SRO number before returning the modem to us.

Ship the unit, postage paid, in a strong box made of corrugated cardboard with plenty of

packing material. **DO NOT** send the modem back in the original box.

Send **ONLY** the modem (**NOT** the power supply, manuals, CD-ROM, etc.).

Include your SRO number, name, and address on the shipping label as well as inside the package.

Send the package via a courier capable of tracking the progress of the shipment.

Ship to the following address:

3Com
Attn: RMA
SRO# _____
6201 W. Oakton, East Dock
Morton Grove, IL 60053

GLOSSARY

Cross references are printed in **boldface**.

Cross references with items in the Command Summary, found in the Technical Quick Reference, are printed in *italics*.

analog loopback

A modem self-test in which data from the keyboard or an internal test pattern is sent to the modem's transmitter, turned into analog form, looped back to the receiver, and converted back into digital form.

analog signals

A variety of signals and wavelengths that can be transmitted over communications lines such as the sound of a voice over the phone line. Contrast with **digital signals**.

answer mode

The mode used by your modem when answering an incoming call from an originating modem. The transmit/receive frequencies are the reverse of the originating modem, which is in **originate mode**.

application

A computer program designed to perform a specific function, such as word processing or organizing data into a spreadsheet.

ARQ

Automatic Repeat reQuest. A general term for a function that automatically allows your modem to detect flawed data and retransmit it. See **MNP** and **V.42**.

GLOSSARY

ASCII

American Standard Code for Information Interchange. A code used to represent letters, numbers, and special **characters** such as \$, !, and /.

asynchronous transmission

Data transmission in which the length of time between transmitted **characters** may vary. Because the time lapses between transmitted characters are not uniform, the receiving modem must be signaled as to when the data bits of a character begin and when they end. The addition of **start/stop bits** to each character serves this purpose.

Auto Answer

Sets the modem to pick up the phone line when it detects a certain number of rings. See S-register *S0* in the “Technical Quick Reference.”

auto dial

A process where your modem dials a call for you. The dialing process is initiated by sending an *ATDT* (dial tone) or *ATDP* (dial pulse) command followed by the telephone number to dial. Auto dial is used to dial voice numbers. See command *Dn*.

baud rate

A term used to measure the speed of an analog transmission from one point to another. Although not technically accurate, baud rate is commonly used to mean **bit rate**.

GLOSSARY

binary digit

A 0 or 1, reflecting the use of the binary numbering system (only two digits). Used because the computer recognizes either of two states, OFF or ON. Shortened form of binary digit is bit.

bit rate

Also referred to as transmission rate. The number of **binary digits**, or bits, transmitted per second (**bps**). Communications channels using telephone channel modems are established at set bit rates, commonly 2400, 4800, 9600, 14,400, 28,800 and higher.

bits per second (bps)

The bits (**binary digits**) per second rate. Thousands of bits per second are expressed as kilobits per second or Kbps.

buffer

A memory area set aside to be used as temporary storage during input and output operations. An example is the modem's command buffer.

byte

A group of **binary digits** stored and operated upon as a unit. In user documentation, the term usually refers to 8-bit units or **characters**. One kilobyte (KB) is equal to 1,024 bytes or characters; 640 KB indicates 655,360 bytes or characters.

carrier

The basic tone or signal that the modem alters (modulates) to send data.

GLOSSARY

character

A representation, coded in **binary digits**, of a letter, number, or other symbol.

characters per second (CPS)

A data transfer rate generally estimated from the **bit rate** and the **character length**. For example, at 2400 bps, 8-bit characters with **start/stop bits** (for a total of ten bits per character) will be transmitted at a rate of approximately 240 characters per second (cps). Some **protocols**, such as error-control protocols, employ advanced techniques such as longer transmission **frames** and **data compression** to increase cps.

class 1 and 2.0

International standards used between fax **application** programs and faxmodems for sending and receiving faxes.

cyclic redundancy checking (CRC)

An error-detection technique consisting of a test performed on each block or **frame** of data by both sending and receiving modems. The sending modem inserts the results of its tests in each data block in the form of a **CRC code**. The receiving modem compares its results with the received **CRC code** and responds with either a positive or negative acknowledgment.

data communications

Communications between computers utilizing an electronic medium.

GLOSSARY

data compression table

A table containing values assigned for each **character** during a call under **MNP5** data compression. **Default** values in the table are continually altered and built during each call. The longer the table, the more efficient the **throughput**.

data mode

The mode used by a faxmodem to send and receive data.

DCE

Data communications (or Circuit-Terminating) equipment, such as dial-up modems that establish and control the data link via the telephone network.

default

Any settings assumed, at installation, startup or reset, by the computer's software and attached devices. These settings remain in effect until changed by the user or other software.

detect phase

In the **ITU-T V.42** error-control **protocol**, the first stage in establishing if both modems attempting to connect have **V.42** capability.

dictionary

The term used for compression codes built by the **V.42 bis** data compression algorithm.

GLOSSARY

digital loopback

A test that checks the modem's RS-232 interface and the cable that connects the **terminal** or computer and the modem. The modem receives data (in the form of **digital signals**) from the computer or terminal, and immediately returns the data to the screen for verification.

digital signals

Discrete, uniform signals. In this manual, the term refers to the **binary digits** 0 and 1. Contrast with **analog signals**.

DTE

Data **terminal** (or terminating) equipment. A computer that generates or is the final destination of data.

duplex

Indicates a communications channel capable of carrying signals in both directions. See **half duplex**, **full duplex**.

Electronic Industries Association (EIA)

Group which defines electronic standards in the U.S.

error control

Various techniques that check the reliability of **characters (parity)** or blocks of data. **V.42** and **MNP** error-control **protocols** use error detection (**CRC**) and retransmission of flawed **frames (ARQ)**.

facsimile

A method for transmitting the image on a page from one point to another. Commonly referred to as fax.

GLOSSARY

fax mode

The mode in which the faxmodem is capable of sending and receiving files in a **facsimile** format. See definitions for **V.17**, **V.27ter**, **V.29**.

flow control

A mechanism that compensates for differences in the flow of data into and out of a modem or other device. See commands *&Hn*, *&In*, *&Rn*.

frame

A **data communications** term for a block of data with header and trailer information attached. The added information usually includes a frame number, block size data, error-check codes, and Start/End indicators.

full duplex

Capable of signal flow in both directions simultaneously. In microcomputer communications, may refer to the suppression of the online **local echo**.

half duplex

Capable of signal flow in both directions, but signals may flow only one way at a time. In microcomputer communications, may refer to activation of the online **local echo**, which causes the modem to send a copy of the transmitted data to the screen of the sending computer.

Hz

Hertz, a frequency measurement unit used internationally to indicate one cycle per second.

GLOSSARY

ITU-T

An international organization that defines standards for telegraphic and telephone equipment. For example, the Bell 212A standard for 1200-bps communication in North America is observed internationally as ITU-T **V.22**. For 2400-bps communication, most U.S. manufacturers observe V.22 bis. The initials ITU-T represent the French name. In English it is known as the International Telegraph and Telephone Consultative Committee.

LAPM

Link Access Procedure for Modems. An error-control **protocol** defined in **ITU-T** Recommendation V.42. Like the **MNP** protocols, LAPM uses **cyclic redundancy checking (CRC)** and retransmission of corrupted data (**ARQ**) to ensure data reliability.

local echo

A modem feature that enables the modem to display keyboard commands and transmitted data on the screen. See command *Hn*.

MNP

Microcom Networking Protocol, an error-control **protocol** developed by Microcom, Inc., and now in the public domain. There are several different MNP protocols, but the most commonly used one ensures error-free transmission through error detection (**CRC**) and retransmission of erred **frames**.

modem

A device that transmits/receives computer data through a communications channel such as radio or telephone lines. It also changes signals received from the phone line back to **digital signals** before passing them to the receiving computer.

nonvolatile memory (NVRAM)

User-programmable random access memory whose data is retained when power is turned off. On the Sportster, it includes four stored phone numbers and the modem settings.

off/on hook

Modem operations that are the equivalent of manually lifting a phone receiver (taking it off-hook) and replacing it (going on-hook).

online fall back/fall forward

A feature that allows high-speed, error-control modems to monitor line quality and fall back to the next lower speed in a defined range if line quality diminishes. As line conditions improve, the modems switch up to the next higher speed.

GLOSSARY

originate mode

The mode used by your modem when initiating an outgoing call to a destination modem. The transmit/receive frequencies are the reverse of the called modem, which is in **answer mode**.

parity

A simple error-detection method that checks the validity of a transmitted **character**. Character checking has been surpassed by more reliable and efficient forms of error checking, including **V.42** and **MNP 2-4 protocols**. Either the same type of **parity** must be used by two communicating computers, or both may omit parity.

protocol

A system of rules and procedures governing communications between two or more devices. Protocols vary, but communicating devices must follow the same protocol in order to exchange data. The format of the data, readiness to receive or send, error detection and error correction are some of the operations that may be defined in protocols.

RAM

Random Access Memory. Memory that is available for use when the modem is turned on, but that clears of all information when the power is turned off. The modem's RAM holds the current operational settings, a **flow control buffer**, and a command **buffer**.

GLOSSARY

remote digital loopback

A test that checks the phone link and a remote modem's transmitter and receiver.

remote echo

The sending system displays data sent to the remote system. Remote echoing is a function of the remote system.

ROM

Read Only Memory. Permanent memory, not user-programmable.

serial transmission

The consecutive flow of data in a single channel. Compare to parallel transmissions where data flows simultaneously in multiple channels.

start/stop bits

The signaling bits attached to a **character** before the character is transmitted during **asynchronous transmission**.

terminal

A device whose keyboard and display are used for sending and receiving data over a communications link. Differs from a microcomputer or a mainframe in that it has little or no internal processing capabilities.

terminal mode

Software mode that allows direct communication with the modem. Also known as command mode.

GLOSSARY

throughput

The amount of actual user data transmitted per second without the overhead of **protocol** information such as **start/stop bits** or **frame** headers and trailers. Compare with **characters per second**.

V.8

The **ITU-T** standard specification that covers the initial handshaking process.

V.17 fax

An **ITU-T** standard for making **facsimile** connections at 14,400 bps, 12,000 bps, 9,600 bps, 7,200 bps.

V.21

An **ITU-T** standard for modems operating in asynchronous mode at speeds up to 300 bps, **full-duplex**, on public switched telephone networks.

V.22

An **ITU-T** standard for modem communications at 1200 bps, compatible with the Bell 212A standard observed in the U.S. and Canada.

V.22 bis

An **ITU-T** standard for modem communications at 2400 bps. The standard includes an automatic link negotiation fallback to 1200 bps and compatibility with Bell 212A/V.22 modems.

GLOSSARY

V.27

An **ITU-T** standard for **facsimile** operations that specifies modulation at 4800 bps, with fallback to 2400 bps.

V.29

An **ITU-T** standard for **facsimile** operations that specifies modulation at 9600 bps, with fallback to 7200 bps.

V.32

An **ITU-T** standard for modem communications at 9600 bps and 4800 bps. V.32 modems fall back to 4800 bps when line quality is impaired.

V.32 bis

An **ITU-T** standard that extends the V.32 connection range: 4800, 7200, 9600, 12,000, and 14,400 bps. V.32 *bis* modems fall back to the next lower speed when line quality is impaired, fall back further as necessary, and also fall forward (switch back up) when line conditions improve (see **online fall back/fall forward**).

V.34

An **ITU-T** standard that currently allows data rates as high as 33,600 bps.

V.42

An **ITU-T** standard for modem communications that defines a two-stage process of detection and negotiation for **LAPM error control**.

GLOSSARY

V.42 bis

An extension of **ITU-T V.42** that defines a specific data compression scheme for use during V.42 connections.

x2

A technology that uses the digital telephone network to increase the bit rate of the receive channel by eliminating the analog to digital conversion commonly found in modem connections. X2 connections require an X2 capable modem calling a digitally connected X2 capable host.

Xmodem

The first of a family of **error control** software **protocols** used to transfer files between modems. These protocols are in the public domain and are available from many bulletin board services.

XON/XOFF

Standard **ASCII** control **characters** used to tell an intelligent device to stop/resume transmitting data.

Ymodem

An error-checking **protocol** that can send several files of data at a time in 1024-**byte** (1K) blocks. This protocol can use either checksums or CRC for error checking.

Ymodem G

Similar to **Ymodem**, except it includes no error checking, which makes it faster.

Zmodem

Similar to **Xmodem** and **Ymodem**, except it includes batch transfer, the ability to recover from a partially complete transfer, an autostart feature, and improved efficiency

REGULATORY INFORMATION

Manufacturer's Declaration of Conformity

3Com Corporation
7770 North Frontage Road
Skokie, Illinois 60077-2690
U.S.A.

declares that the product *U.S. Robotics 56K Faxmodem* conforms to the FCC's specifications:

Part 15; Subpart B Class B:
Operation is subject to the following two conditions:

- (1) this device may not cause harmful electromagnetic interference, and
- (2) this device must accept any interference

received including interference that may cause undesired operations.

Part 68:

This equipment complies with FCC Rules Part 68. Located on the bottom of the modem is the FCC Registration Number and Ringer Equivalence Number (REN). You must provide this information to the telephone company if requested.

The REN is used to determine the number of devices you may legally connect to your telephone line. In most areas, the sum of the REN of all devices connected to one line must not exceed five (5.0). You should contact your telephone company to determine the maximum REN for your calling area.

REGULATORY INFORMATION

This equipment uses the following USOC jacks: RJ11C.

This equipment may not be used on coin service provided by the telephone company. Connection to party lines is subject to state tariffs.

An FCC compliant telephone cord and modular plug are provided with this equipment, which is designed to connect to the telephone network or premises wiring using a Part 68 compliant compatible jack. See installation instructions for details.

Caution to the User

The user is cautioned that any changes or modifications not expressly approved by the party responsible for compliance could void the user's authority to operate the equipment.

(Canada) IC

This digital apparatus does not exceed the Class B limits for radio noise emissions from digital apparatus set out in the interference-causing equipment standard entitled *Digital Apparatus*, ICES-003 of Industry Canada. Cet appareil numérique respecte les limites de bruits radioélectriques applicables aux appareils numériques de Classe B prescrites dans la norme sur le matériel brouilleur: *Appareils Numériques*, NMB-003 édictée par l'Industrie Canada.

UL Listing/CUL Listing

This information technology equipment is UL-Listed and CUL-Listed for use with UL-Listed personal computers that have installation instructions detailing user installation of card cage accessories.

REGULATORY INFORMATION

Connecting to the Telephone Company

It is not necessary to notify the telephone company before installing the modem. However, the telephone company may request the telephone number(s) to which the U.S. Robotics modem is connected and the regulatory information printed in this section.

Be sure that the telephone line you are connecting the modem to is a standard analog line and not a digital (PBX), party, or coin telephone line.

If the modem is malfunctioning, it may affect the telephone lines. In this case, disconnect the modem until the source of the difficulty is traced.

Fax Branding

The Telephone Consumer Protection Act of 1991 makes it unlawful for any person to use a computer or other electronic device, including fax machines, to send any message unless such message clearly contains in a margin at the top or bottom of each transmitted page or on the first page of the transmission, the date and time it is sent, an identification of the business or other entity, or other individual sending the message, and the telephone number of the sending machine or of such business, other entity, or individual. (The telephone number provided may not be a 900 number or any other number for which charges exceed local or long-distance transmission charges.)

In order to program this information into your U.S. Robotics modem, refer to the RapidComm manual on the CD-ROM that

REGULATORY INFORMATION

shipped with your modem. If you're using a different communications software program, refer to its manual.

Radio and Television Interference

This equipment generates and uses radio frequency energy and if not installed and used properly, in strict accordance with the manufacturer's instructions, may cause interference to radio and television reception. The modem has been tested and found to comply with the limits for a Class B computing device in accordance with the specifications in Part 15 of the FCC rules, which are designed to provide reasonable protection against such interference in a residential installation.

However, there is no guarantee that interference will not occur in a particular installation. If this device does cause

interference to radio or television reception, which you can determine by monitoring reception when the modem is installed and when it is removed from the computer, try to correct the problem with one or more of the following measures:

- Re-orient the receiving antenna (for televisions with antenna reception only) or cable input device.
- Relocate the computer with respect to the receiver.
- Relocate the computer and/or the receiver so that they are on separate branch circuits.

If necessary, consult your dealer or an experienced radio/television technician for additional suggestions. You may find the following booklet, prepared by the Federal Communications Commission, helpful:

REGULATORY INFORMATION

How to Identify and Resolve Radio-TV Interference Problems

Stock No. 004-000-0345-4

U.S. Government Printing Office

Washington, DC 20402

In accordance with Part 15 of the FCC rules, the user is cautioned that any changes or modifications to the equipment described in this manual that are not expressly approved by U.S. Robotics, Inc. could void the user's authority to operate the equipment.

For Canadian Modem Users

NOTICE: The Industry Canada (IC) label identifies certified equipment. This certification means the equipment meets certain telecommunications network protective, operational, and safety

requirements as prescribed in the appropriate Terminal Equipment Technical Requirements document(s). The Department does not guarantee the equipment will operate to the user's satisfaction.

Before installing this equipment, users should ensure that it is permissible to be connected to the facilities of the local telecommunications company. The equipment must also be installed using an acceptable method of connection. In some cases, the company's inside wiring associated with a single-line, individual service may be extended by means of a certified connector assembly (telephone extension cord.) The customer should be aware that compliance with the above conditions may not prevent degradation of service in some situations. Currently, telecommunication companies do not allow

REGULATORY INFORMATION

users to connect their equipment to jacks except in precise situations that are spelled out in tariffing arrangements with those companies.

Repairs to certified equipment should be coordinated by a representative designated by the supplier. Any repairs or alterations made by the user to this equipment, or equipment malfunctions, may give the telecommunications company cause to request the user to disconnect the equipment.

For your own protection, make sure that the electrical ground connections of the power utility, telephone lines, and internal metallic water pipe system, if present, are connected together. This precaution may be particularly important in rural areas.

CAUTION: Do *NOT* attempt to make such connections yourself. Instead, contact an

electric inspection authority or electrician, as appropriate.

NOTICE: The Ringer Equivalence Number (REN) assigned to each terminal device provides an indication of the maximum number of terminals allowed to be connected to a telephone interface. The termination on an interface may consist of any combination of devices subject only to the requirement that the sum of the Ringer Equivalence Numbers of all the devices does not exceed 5.

The Ringer Equivalence Number is located on the bottom of the modem's case (external modems) or on the modem's circuit board (internal modems).

WARRANTY AND REPAIR SERVICE CENTER:

Keating Technologies
25 Royal Crest Court, Suite 200
Markham, ONT L3R 9X4

REGULATORY INFORMATION

AVIS: L'étiquette de Industrie Canada identifie le matériel homologué. Cette étiquette certifie que le matériel est conforme à certaines normes de protection, d'exploitation et de sécurité des réseaux de télécommunications. Le Ministère n'assure toutefois pas que le matériel fonctionnera à la satisfaction de l'utilisateur.

Avant d'installer ce matériel, l'utilisateur doit s'assurer qu'il est permis de le raccorder aux installations de l'entreprise locale de télécommunication. Le matériel doit également être installé en suivant une méthode acceptée de raccordement. L'abonné ne doit pas oublier qu'il est possible que la conformité aux conditions énoncées ci-dessus n'empêche pas la dégradation du service dans certaines situations.

Les réparations de matériel homologué doivent être effectuées par un centre d'entretien canadien autorisé désigné par le fournisseur. La compagnie de télécommunications peut demander à l'utilisateur de débrancher un appareil à la suite de réparations ou de modifications effectuées par l'utilisateur ou à cause de mauvais fonctionnement.

Pour sa propre protection, l'utilisateur doit s'assurer que tous les fils de mise à la terre de la source d'énergie électrique, des lignes téléphoniques et des canalisations d'eau métalliques, s'il y en a, sont raccordé ensemble. Cette précaution est particulièrement importante dans les régions rurales.

REGULATORY INFORMATION

Avertissement: L'utilisateur ne doit pas tenter de faire ces raccordements lui-même; il doit avoir recours à un service d'inspection des installations électriques, ou à un électricien, selon le cas.

NOTICE: L'Indice d'Equivalence de la Sonnerie (IES) de chaque appareil donne une indication du nombre maximal de terminaux qui peut être branché à l'interface téléphonique. La termination d'une interface peut consister de n'importe quelle combinaison d'appareils sur le réseau, seulement si la somme des IES de tous les appareils n'excède pas 5.

L'Indice d'Equivalence de la Sonnerie (IES) est situé au revers du modem (modems externes), ou sur le circuit imprimé (modems internes).

Centre de garantie et de service après-vente:

Keating Technologies
25 Royal Crest Court, Suite 200
Markham, ONT L3R 9X4

Limited Warranty

U.S. Robotics Access Corp., a subsidiary of 3Com Corporation, warrants to the original end-user purchaser that this product will be free from defects in materials and workmanship for a period of five years from the date of purchase. During the limited warranty period, and upon proof of purchase, the product will be repaired or replaced (with the same or a similar model, which may be a refurbished model) at U.S. Robotics' option, without charge for either parts or labor. This limited warranty shall

REGULATORY INFORMATION

not apply if the product is modified, tampered with, misused, or subjected to abnormal working conditions (including, but not limited to, lightning and water damage).

THIS LIMITED WARRANTY DOES NOT GUARANTEE YOU UNINTERRUPTED SERVICE. REPAIR OR REPLACEMENT AS PROVIDED UNDER THIS LIMITED WARRANTY IS THE EXCLUSIVE REMEDY OF THE PURCHASER. THIS LIMITED WARRANTY IS IN LIEU OF ALL OTHER WARRANTIES, EXPRESS OR IMPLIED, INCLUDING, BUT NOT LIMITED TO, ANY IMPLIED WARRANTY OF MERCHANTABILITY OR FITNESS FOR A PARTICULAR USE OR PURPOSE. U.S. ROBOTICS SHALL IN

NO EVENT BE LIABLE FOR ANY SPECIAL, INDIRECT, INCIDENTAL, PUNITIVE, OR CONSEQUENTIAL DAMAGES OF ANY KIND OR CHARACTER, INCLUDING, WITHOUT LIMITATION, LOSS OF REVENUE OR PROFITS, FAILURE TO REALIZE SAVINGS OR OTHER BENEFITS, LOSS OF DATA OR USE, DAMAGE TO EQUIPMENT, AND CLAIMS AGAINST THE PURCHASER BY ANY THIRD PERSON, EVEN IF U.S. ROBOTICS HAS BEEN ADVISED OF THE POSSIBILITY OF SUCH DAMAGES.

This limited warranty gives you specific legal rights. You may have others, which vary from state to state. Some states do not allow limitations on duration of an implied

REGULATORY INFORMATION

warranty, or the exclusion or limitation of incidental or consequential damages, so the above exclusion or limitation may not apply to you.

To obtain service under this limited warranty, contact the 3Com Technical Support Department at 847-982-5151 or by mail at 3Com, 7770 N. Frontage Road, Attn.: Technical Support Dept., Skokie, Illinois 60077-2690. You will be given a Service Repair Order (“SRO”) number to help U.S. Robotics keep track of your limited warranty request. Once you have received your SRO number, take or send the product, postage prepaid and insured, to 3Com, Attn: RMA, [your SRO#], 6201 W. Oakton, East Dock, Morton Grove, IL 60053. Pack the modem in a strong corrugated cardboard box with plenty of packing material. DO NOT send the

modem back in its original box. DO NOT send anything but the modem (do not send back the power supply, CD-ROM, documentation, etc.). If possible, send the modem via a courier capable of tracking the progress of the shipment. Include proof of the date of purchase. IMPORTANT: If you send your unit, pack it securely, and be sure that your SRO number is visible on the outside of the package.